

Spring-loaded pressure piece

0303416 PZN-plus 240-2

Spring-loaded pressure piece 0303416 PZN-plus 240-2 (PDF)

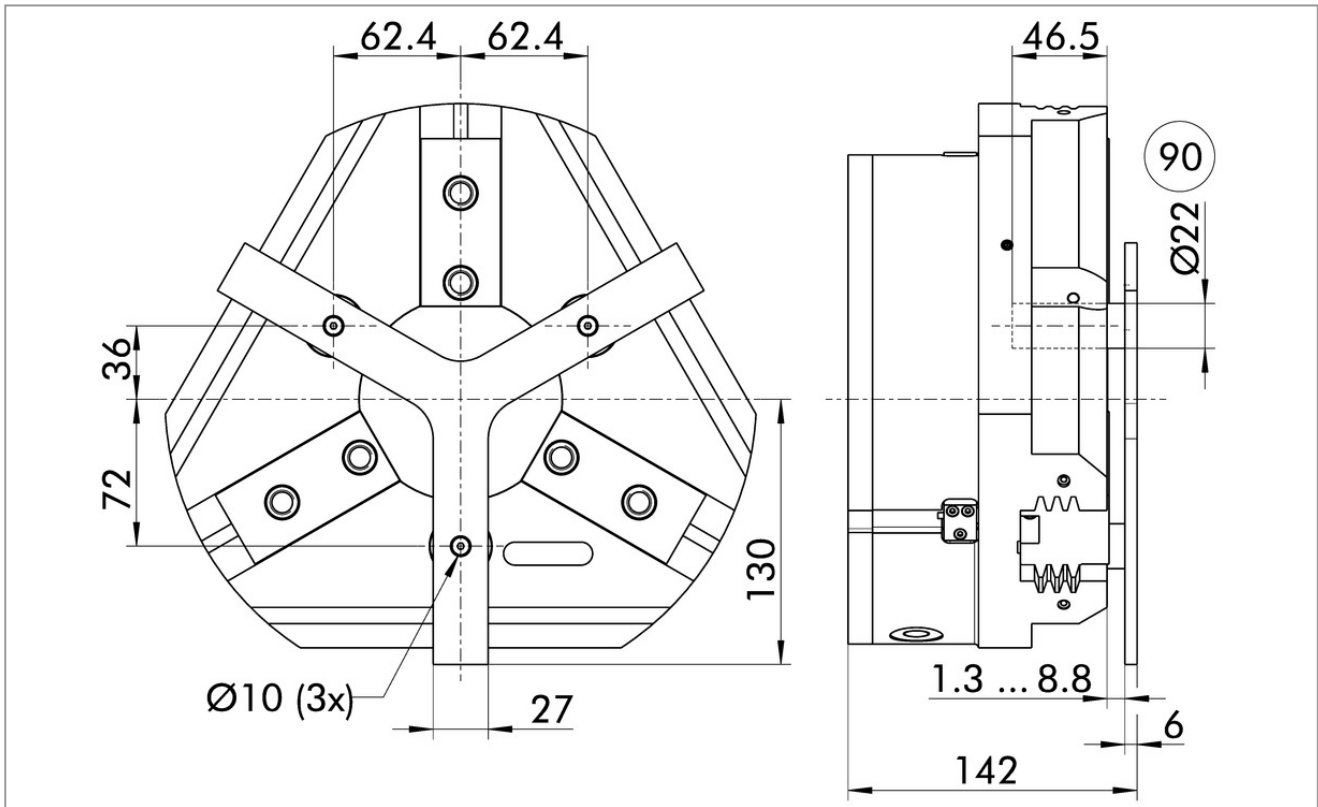

For spring-supported positioning of the workpiece against a stop after the gripper has opened. Especially developed for loading machines.

⑨ Guide pin

i The pressure piece cannot be combined with the dust-tight option. Please contact us if you require a customized pressure piece.